

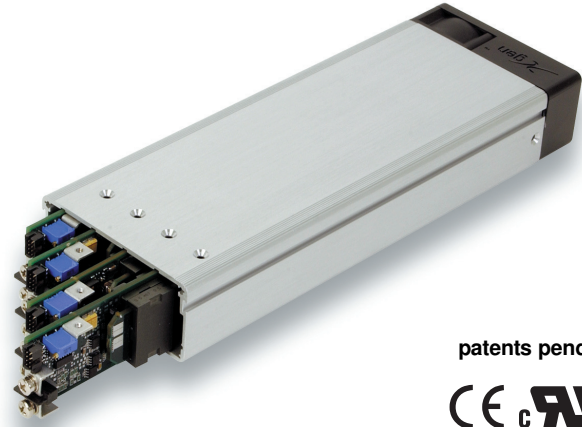

## Slimline Power Supply

User Configurable 1U size



patents pending



Slimline

### PLUG & PLAY POWER next generation power source

#### FEATURES

- Slimmest 750W configurable power
- Extra low profile: 1U height (40mm)
- Up to 800W peak power
- Ultra high efficiency, up to 89%
- Plug & Play Power
  - allows fast custom configuration
  - allow easy logistics
- FLEXIMOUNT Flexible mounting system
- Few electrolytic capacitors (all long life)
- Visual LED indicators
- Series / Parallel of multiple outputs
- 5V bias standby voltage provided
- Individual output control signals

#### APPLICATIONS INCLUDE

- Industrial machines
- Test and measurement
- Automation equipment
- Printing
- Telecommunications
- For Medical applications see Xmite

The XLD is the latest addition to the Xlite family of power supplies and provides an unprecedented 750W in a slimline 1U x 268 x 89mm package. Providing up to 8 isolated outputs, the Xlite family is the most flexible power supply in its class and brings affordable configurable power to the 750W market.

With 800W peak power capability the slimline product boasts unrivalled power density saving valuable system space. Combine with ultra high efficiencies, the Xlite family provides system designers with flexible instant solutions that significantly shorten and simplify system design-in time.

The XLD 750W *powerPac* model may be populated with up to 4 *powerMods* selected from the table of *powerMods* shown below.

All configurations carry full safety agency approvals, UL60950, EN60950 and are CE marked. For alternative power interfaces contact [support@excelsys.com](mailto:support@excelsys.com)

#### powerMods

MODEL	Vtrim	Vmin <sup>(4)</sup> Vpot	Vnom	Vmax <sup>(4)</sup>	I <sub>max</sub>	Watts
Xg1	1.0	1.5	2.5	3.6	50A	125W
Xg2	1.5	3.2	5.0	6.0	40A	200W
Xg3	4.0	6.0	12.0	15.0	20A	240W
Xg4	8.0	12.0	24.0	30.0	10A	240W
Xg5	8.0	24.0	48.0	58.0	6A	288W
Xg7	5.0	5.0	24.0	28.0	5A	120W
Xg8	v1	5.0	5.0	24.0	3A	72W
	v2	5.0	5.0	24.0	3A	72W

#### powerPacs

MODEL	Watts
XLD	750W

#### EFFICIENCY (typical)

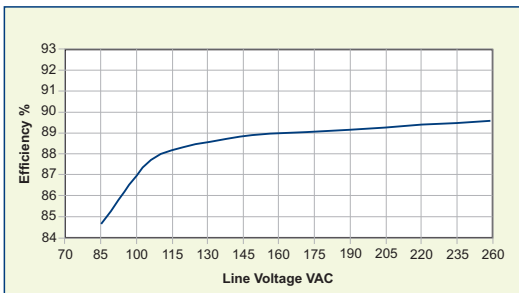

#### MECHANICAL SPECIFICATIONS

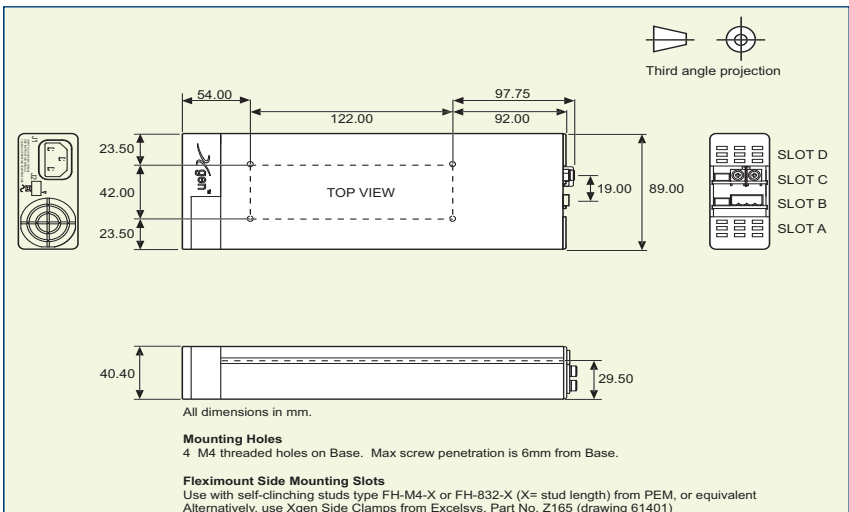

**SPECIFICATION** applies to configured units consisting of *powerMods* modules plugged into the appropriate *powerPac*

INPUT					
Parameter	Conditions/Description	Min	Nom	Max	Units
Input Voltage Range	Universal Input	85		264	VAC
		120		380	VDC
Input Frequency Range		47		63	Hz
Power Rating XLD	Derate linearly from 750W at 140VAC to 525W at 85VAC. Note 5			750(800)	W
Input Current XLD	85VAC in 525W out		7.5		A
Inrush Current	230VAC @ 25°C			50	A
Undervoltage Lockout	Shutdown	65		74	VAC
Fusing XLD	250V 5 x 20mm		F8A HRC		

OUTPUT					
Parameter	Conditions/Description	Min	Nom	Max	Units
<i>powerMod</i> Power	As per <i>powerMod</i> table				
Output Adjustment Range	Manual: Multi-turn potentiometer. As per <i>powerMod</i> table				
	Electronic: See Xgen Designers' Manual				
Minimum Load			0		A
Line Regulation	For ±10% change from nominal line			±0.1	%
Load Regulation	For 25% to 75% load change			±0.2	%
Cross Regulation				±0.2	%
Transient Response	For 25% to 75% load change Voltage Deviation Settling Time			10	%
				250	µs
Ripple and Noise	20MHz Bandwidth			1.0	% pk-pk
Overvoltage Protection	Two-level. 1st level: Vset Tracking. 2nd level: Vmax (Latching)	110		125	%
Overcurrent Protection	Straight line with hiccup activation at <30% of Vnom See Designer's Manual for full details	110		120	%
Remote Sense	Max. line drop compensation. (except Xg7, Xg8)			0.5	VDC
Overshoot				2	%
Turn-on Delay	From AC In / Enable signal			1000/ 30	ms
Rise Time	Monotonic			5	ms
Hold-up Time	For nominal output voltages at full load	15			ms
Output Isolation	Output to Output / Output to Chassis	500 / 500			VDC

GENERAL					
Parameter	Conditions/Description	Min	Nom	Max	Units
Isolation Voltage	Input to Output	3000			VAC
	Input to Chassis	1500			VAC
Efficiency	230VAC, 750W @ 24V		89		%
Safety Agency Approvals	EN60950, UL60950, CSA22.2 No.950 UL File No. E181875				
Leakage Current	250VAC, 60Hz, 25°C			1.5	mA
Signals	See Xgen Series datasheet				
Bias Supply	Always ON. Current 250mA	4.8	5.0	5.2	VDC
Reliability	Failures per million hours at 25°C and full load <i>powerMod</i>			0.98	fpmh
	See Designers' Manual. <i>powerPac</i> excludes fans <i>powerPac</i>			0.92	fpmh

EMC					
Parameter	Standard		Level		Units
<b>Emissions</b>					
Conducted	EN55011, EN55022, FCC		Level B		
Radiated	EN55011, EN55022, FCC		Level B		
Harmonic Distortion	EN61000-3-2		Compliant		
Flicker and Fluctuation	EN61000-3-3		Compliant		
<b>Immunity</b>					
Electrostatic Discharge	EN61000-4-2		Level 4		
Radiated RFI	EN61000-4-3		Level 3		
Fast Transients - burst	EN61000-4-4		Level 4		
Input Line Surges	EN61000-4-5		Class 4		
Conducted RFI	EN61000-4-6		10		V/m
Voltage Dips	EN61000-4-11 (EN55024)		10		ms

ENVIRONMENTAL					
Parameter	Conditions/Description	Min	Nom	Max	Units
Operating Temperature		-20		+70	°C
Storage Temperature		-40		+85	°C
Derating	0.667% per °C 40-60°C.; 1.33% per per °C 60-70°C				
Relative Humidity	Non-condensing	5		95	%RH
Shock	3000 Bumps, 10G (16ms) half sine				
Vibration	1.5G	10		200	Hz

- NOTES**
1. This product is not intended for use as a stand alone unit and must be installed by qualified personnel.
  2. The specifications contained herein are believed to be correct at time of publication and are subject to change without notice.
  3. All specifications at nominal input, full load, 25°C unless otherwise stated.
  4. Vmin and Vmax voltages achieved when using Vtrim function on powerMod. Voltage setpoints can also be adjusted using on board potentiometer. See Xgen series Designers' Manual for full details on Vtrim and adjustment ranges.
  5. 800W peak for 1s; Duty cycle 7%. powerMod output power must not exceed normal ratings.
  6. When powering inductive or capacitive loads, it is recommended to use a blocking diode on the output.

Doc. XLD Rev02 11/09



<b>Europe/Asia</b>		<b>North America</b>	
Excelsys Technologies Ltd	t: +353 21 4354716	Excelsys Technologies	t: (972) 771 4544
27 Eastgate Drive	f: +353 21 4354864	519 Interstate 30, #309	f: (972) 421 1805
Eastgate Business Park	e: sales@excelsys.com	Rockwall, TX 75087	e: salesusa@excelsys.com
Little Island, Cork, Ireland		USA	
IRELAND			

## Voltage Adjustment - Local

The multi-turn potentiometer that adjusts each output within the specified range may be accessed via the output panel of the power supply. Clockwise rotation increases output voltage. Resolution is approximately 5% of nominal voltage (Vnom) per turn.

## Voltage Adjustment - Remote (resistive / electronic)

The output voltage may be adjusted or trimmed by means of an external resistor or potentiometer network connected to the Vtrim pin. Linear Electronic programming is also possible and may be implemented according to the formula  $V_{out} = K V_{control}$ . See Xgen series Designers' Manual for full details.

## Paralleling

To achieve increased current capacity, simply parallel outputs using the standard parallel links. Excelsys 'wireless' sharing ensures that current hogging is not possible. To parallel connect outputs:

1. Switch on IShare switch to ON on powerMods.
2. Connect Negative parallel link.
3. Adjust output voltages of powerMods to within 5mV of each other.
4. Connect Positive Parallel Link.

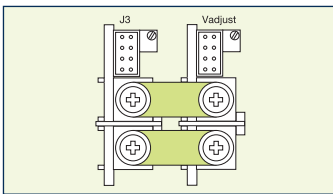

Parallel Links available to order. Part Number XP1

## Seriesing

To achieve increased output voltages, simply series outputs using standard series links, paying attention to the requirements to maintain SELV levels if required in your system.

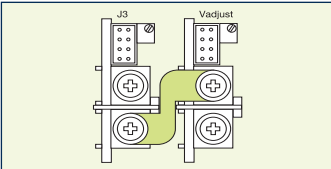

Series Links available. Part Number XS1

## Remote Sensing

When the load is remote from the power supply, the remote sense pins may be used to compensate for drops in the power leads. Where the power cabling contributes significant dynamic impedance, see Xgen series Designers' Manual.

## Bias Voltage

A SELV isolated 5V (always on) bias voltage rated at 250mA is provided on J2 to facilitate miscellaneous control functions.

## Current Limit Adjustment

The output current limit setting may be adjusted (downwards only) by means of an external resistor connection to the I trim pin.

## Inhibit/Enable

Inhibiting may be implemented either globally or on a per module basis (*powerPac* or *powerMod* inhibiting). Reverse logic (Enabling) may also be implemented, see Xgen series Designers' Manual.

## AC Fail

Open collector signal indicating that the input voltage has failed or is less than 80Vac. This signal changes state giving 5mS of warning before loss of output regulation. See Xgen series Designers' Manual for full specifications.

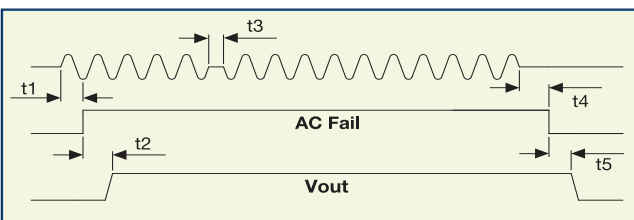

## Temperature Alarm (Option 01)

Open collector signal indicating excessive *powerPac* temperatures due to fan failure or operation beyond ratings. This signal is activated at least 10ms prior to system shutdown.

## Fan Fail (Option 01)

Open collector signal indicating that at least one of the system fans have failed. This does not cause system shutdown.

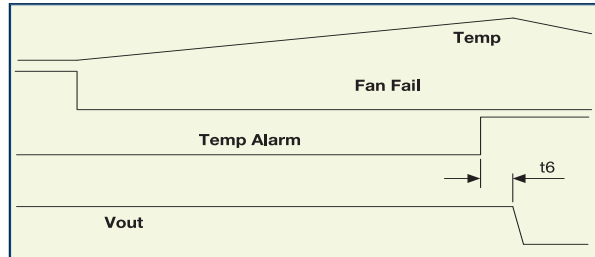

## Power Good

Opto-isolated output signal indicates that the *powerMod* is operating correctly and output voltage is within normal band. Opto transistor ON = Good.

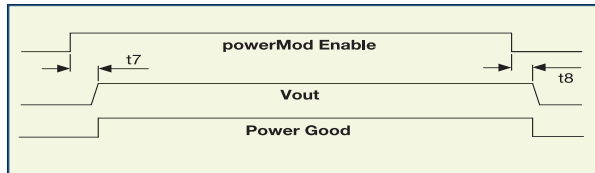

## Indication LEDs

Each powerMod has a visual indicator to identify that it is operating within normal ratings. Very useful for system diagnosis.

## Signal Connector Pinout

Pin	J2 ( <i>powerPac</i> )	J3 ( <i>powerMod</i> ) Type A	J3 ( <i>powerMod</i> ) Type B)
1	common	+sense	+pg (V2)
2	+5V bias	-sense	-pg (V2)
3		V trim	inhibit (V2)
4	ac fail	I trim	common (V2)
5	fan fail*	+inhibit/enable	+pg (V1)
6	global enable	-inhibit/enable	-pg (V1)
7	temp alarm*	+power good	inhibit (V1)
8	global inhibit	-power good	common (V1)

\*Option 01 only

## Signal Connector Pinout

### TYPE A Xg1-Xg7

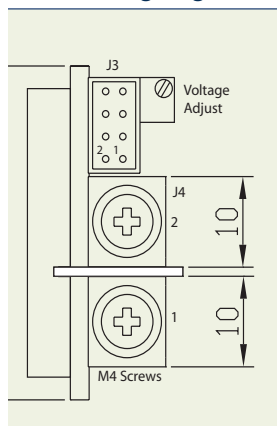

J4 Connector : M4 Screw

J3 Connector Mating Connector  
Housing: Locking Molex 51110-0860  
Non Locking Molex 51110-0850  
Crimp Terminal: Molex p/n 50394

### TYPE B : Xg8

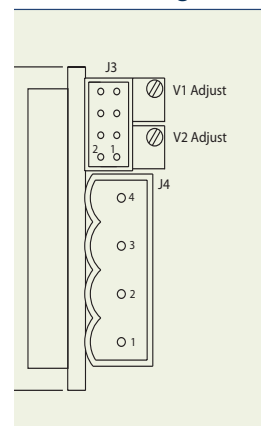

J4Connector : Camden 9200/4A

J3 Connector Mating Connector  
Housing: Locking Molex 51110-0860  
Non Locking Molex 51110-0850  
Crimp Terminal: Molex p/n 50394

See Xgen series Designers' Manual for full signal connector details.



**powerPacs** (4slot package, 89mm wide)



	Family	MODEL	Watts
Standard	Xlite	XLA	200W
		XLB	400W
		XLC	600W
		XLD	750W
Low Noise	Xkite	XKA	200W
		XKB	400W
		XKC	600W

	Family	MODEL	Watts
Med	Xmite	XMA	200W
		XMB	400W
		XMC	600W
		XMD	750W
		XME	1000W
Low Noise Med	Xrite	XRA	200W
		XRB	400W
		XRC	600W



**powerPacs** (6slot package, 127mm wide)

	Family	MODEL	Watts
Standard	Xcite	XCA	400W
		XCB	700W
		XCC	1000W
		XCD	1200W
		XCE	1340W
High Temp	Xhite	XHA	400W
		XHB	600W
Low Noise	Xqite	XQA	400W
		XQB	900W
		XQC	1200W

	Family	MODEL	Watts
Med	Xvite	XVA	400W
		XVB	700W
		XVC	1000W
		XVD	1200W
		XVE	1340W
Low Noise Med	Xzite	XZA	400W
		XZB	900W
		XZC	1200W

**powerMods** (for use with all powerPac models)

MODEL	Vmin <sup>(4)</sup>		Vnom	Vmax <sup>(4)</sup>		Imax	Watts
	Vtrim	Vpot					
Xg1	1.0	1.5	2.5	3.6	50A	125W	
Xg2	1.5	3.2	5.0	6.0	40A	200W	
Xg3	4.0	6.0	12.0	15.0	20A	240W	
Xg4	8.0	12.0	24.0	30.0	10A	240W	
Xg5	8.0	24.0	48.0	58.0	6A	288W	
Xg7	5.0	5.0	24.0	28.0	5A	120W	
Xg8	v1	5.0	5.0	24.0	28.0	3A	72W
	v2	5.0	5.0	24.0	28.0	3A	72W

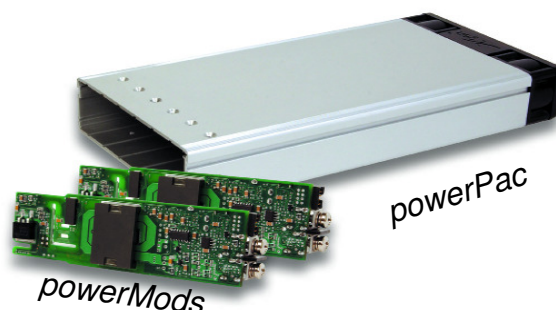

## Part Numbering

**Configured Units** may be specified and ordered using the part numbering system shown opposite. For example, part number XVC123400-00 specifies the following 1000W medical power supply.

- XVC-00 powerPac 1000W medically approved powerPac
- Xg1 2.5V @ 50A powerMod
- Xg2 5V @ 40A powerMod
- Xg3 12V @ 20A powerMod
- Xg4 24V @ 10A powerMod

## Accessories

PowerMods can be parallel connected for higher current and series connected for higher voltages. Configured units will have parallel and series links fitted as required.

